

Oki, Network Solutions
for a Global Society



MICROLINE[®] 520/521 User's Guide

58351801

Every effort has been made to ensure that the information in this document is complete, accurate and up-to-date. OKIDATA assumes no responsibility for the results of errors beyond its control. OKIDATA also cannot guarantee that changes in software and equipment made by other manufacturers, and referred to in this handbook, will not affect the applicability of the information in this handbook. Mention of software products manufactured by other companies does not necessarily constitute endorsement by OKIDATA.

© 1993, 1995, 1996, 1997, 1998, 2001 by OKIDATA
Revised edition, September, 2001

Written and produced by the OKIDATA Training & Publications Department. Please address any comments on this publication

- by mail to:
Training & Publications Department
Okidata, Div. of Oki America, Inc.
2000 Bishops Gate Blvd.
Mount Laurel, NJ 08054-4620
- or by e-mail to: pubs@okidata.com

We welcome you to visit our web site:
<http://www.okidata.com>

Year 2000 Compliance

All products currently sold by Okidata are Year 2000 Compliant. Each product contains information technology that accurately processes date and time data between the years 1999 and 2000. These products, when used in combination with products purchased from other manufacturers, whose products properly exchange date and time information, will accurately process the date and time. All future products are committed to meeting the same Year 2000 compliance.

ENERGY STAR



As an ENERGY STAR® Partner, Okidata has determined that this product meets the ENERGY STAR guidelines for energy efficiency.

OKIDATA, OKILINK and MICROLINE are registered trademarks of Oki Electric Industry Company, Ltd. OKIDATA and MICROLINE: marques déposées de Oki Electric Industry Company, Ltd. OKIDATA: marca registrada, Oki Electric Industry Company, Ltd. Epson is a registered trademark of Epson America, Inc. IBM is a registered trademark of International Business Machines Corporation. Microsoft is either a registered trademark or a trademark of Microsoft Corporation in the United States and/or other countries.

Important Safety Instructions

Your OKI printer has been carefully designed to give you years of safe, reliable performance. As with all electrical equipment, there are a few basic precautions you should take to avoid hurting yourself or damaging the printer:

- Read the setup and operating instructions in this manual carefully. Be sure to save it for future reference.
 - Read and follow all warning and instruction labels on the printer itself.
 - Unplug the printer before you clean it. Use only a damp cloth; do not use liquid or aerosol cleaners.
 - Place your printer on a firm, solid surface. If you put it on something unsteady, it might fall and be damaged; if you place it on a soft surface, such as a rug, sofa, or bed, the vents may be blocked, causing it to overheat.
 - To protect your printer from overheating, make sure no openings on the printer are blocked. Do not put the printer on or near a heat source, such as a radiator or heat register. If you put the printer in any kind of enclosure, make sure it is well ventilated.
- The printhead can get quite hot when it has been printing for a length of time. Do not touch the printhead until it has had a chance to cool off.
 - Do not use your printer near water, or spill liquid of any kind into it.
 - Be certain that your power source matches the rating listed on the back of the printer. If you are not sure, check with your dealer or with your local power company.
 - Your printer has a grounded, 3-prong plug as a safety feature, and it will only fit into a grounded outlet. If you can not plug it in, chances are that you have an older, non-grounded outlet; have an electrician replace it with a grounded outlet. Do *not* use an adapter to defeat the grounding.
 - The printer must be installed near a power outlet which remains easily accessible.
 - To avoid damaging the power cord, do not put anything on it or place it where it will be walked on. If the cord becomes damaged or frayed, replace it immediately.

- If you're using an extension cord or power strip with the printer, make sure that the total of the amperes required by all the equipment on the extension is less than the extension's rating. Generally, the total ratings of all equipment plugged into any one power line should not exceed 15 amps. Don't exceed this unless you know that the power line your equipment is plugged into has a rating above 15 amps.
- Aside from the routine maintenance described in this handbook, don't try to service the printer yourself; opening the cover may expose you to shocks or other hazards. Don't make any adjustments other than those outlined in the manual — you might cause damage requiring extensive repair work. the *Warranty, Regulatory, and Safety Information* booklet supplied with your printer explains how to get your printer serviced by qualified Okidata technicians.

- If anything happens that indicates that your printer is not working properly or has been damaged, unplug it immediately and follow the procedures in the *Warranty, Regulatory, and Safety Information* booklet supplied with your printer for having your printer serviced.

Some of the things to look for:

- The power cord or plug is frayed or damaged.
- Liquid has been spilled into the housing, or the printer has been exposed to water.
- The printer has been dropped or its cabinet has been damaged.
- The printer doesn't function normally when you're following the operating instructions.

Contents

Section 1: Getting Started	1
Unpack	1
Remove The Protective Film	1
Remove The Shipping Retainers	2
Install/Replace the Ribbon	
Cartridge	3
Connect to Power and Computer	5
Power Up	6
Load Paper	6
Loading Rear-Feed Paper	7
Loading Single-Sheet Paper	10
Set the Top of Form	12
Run the Self Tests	13
Selecting an Emulation	13
Changing Emulations	13
Selecting a Printer Driver	14
Printer Drivers	14
Okidata Drivers	14
Section 2: Maintaining Your Printer	15
Replacing the Ribbon Cartridge	15
Clearing Paper Jams	15
Clearing Rear Feed Jams	15
Clearing Single Sheet Feed Jams	16
Cleaning the Housing	17

Section 3: Using Your Printer	19
Control Panel Indicator Lights	19
Control Panel Buttons: Print Mode	20
Control Panel Buttons: Menu Mode	21
Print Mode	22
Selecting Print Quality	22
Selecting Character Pitch	23
Menu Mode	24
Entering The Menu Mode	24
Exiting The Menu Mode	24
Resetting The Menu	24
Printing Out the Menu	24
Sample Default Menu Printout	25
Summary of Menu Settings	26
Explanation of Menu Items	29
Using the Printer's Features	32
Tear Feature	32
Forms Tear-off Feature	32
Paper Park Feature	33
Section 4: Problem Solving	35
Section 5: Specifications	39
Section 6: Parts & Accessories	43
Before You Order	43
How to Order	43
Replacement Parts	43
Manuals	44
Accessories	44

Section 7: Commands 45
Epson FX Commands 45
IBM Proprinter III Commands 47
Okidata MICROLINE Standard Commands 49

FCC/IC/CE Statements 51
FCC RFI Statement for 120V Models 51
IC RFI Statement for 120V Models 51
FCC RFI Statement for 230/240V Models 52
IC RFI Statement for 230/240V Models 52
CE Statements 52
Electromagnetic Conformance for 230/240V Models 52
Safety Conformance for 230/240V Models 52

Index 53

Material Safety Data Sheet 57

Conventions Used in This Guide

The following conventions are used in this guide:

- Notes containing general information are preceded by the Note icon.

For example:

✓ Interface cable and paper are sold separately.

- Statements containing precautions against actions which could cause printing problems or damage to the printer are set in italics, preceded by the Caution icon.

For example:

! *Leave the ribbon shield on the cartridge!*

- Statements containing precautions against actions which could cause personal injury are set in **bold italics**, preceded by the Warning icon.

For example:

⚡ ***Make sure the outlet is grounded. Do not use an adapter to defeat the grounding.***

Section 1: Getting Started

Unpack

Choose a sturdy table, desk or printer stand to place your printer on when you remove it from the carton. Be sure to save all packing materials in case you need to ship the printer again. Check the box for these contents:

- ① Printer
 - ② Ribbon cartridge
 - ③ Power cord
- ✓ Interface cable and paper are sold separately.

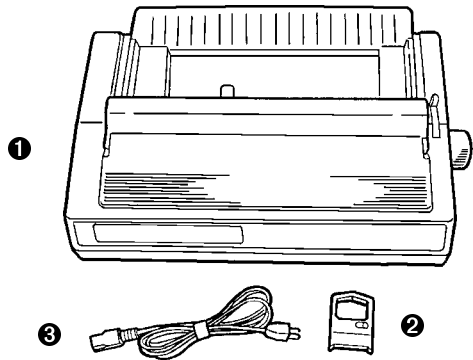

If any of these items is missing or damaged, see your dealer immediately for a replacement.

Remove The Protective Film

1. Peel the clear protective film from the carriage cover.

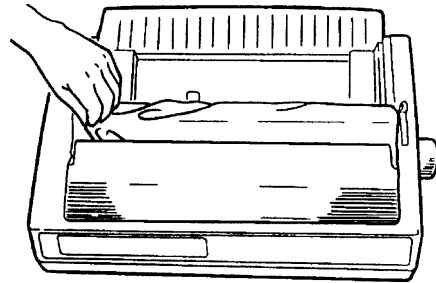

2. Lift up on the ridged area at either end of the carriage cover.

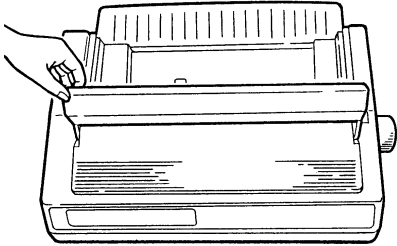

3. Peel the clear protective film from the access cover.

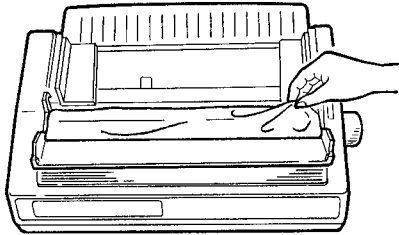

4. Press the carriage cover back into place.

Remove The Shipping Retainers

1. Open the access cover (1) by grasping the tabs at either end and lifting, then remove the printhead shipping retainer (2), leaving the cover open for installation of the ribbon.

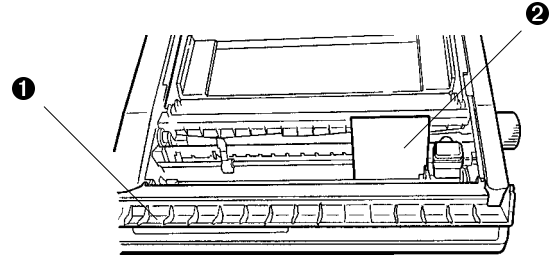

2. Grasp the front edge of the paper separator (3) and pull it up.

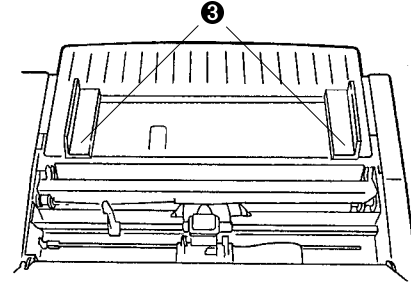

4. Remove the styrofoam shipping retainer, then lower the paper separator and press it into place.

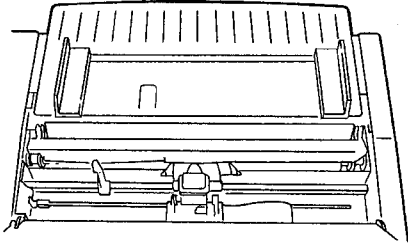

 *It is recommended that the printer be switched off prior to opening or removing the access cover.*

Install/Replace the Ribbon Cartridge

- ✓ Be sure to use only ribbons specifically designated for MICROLINE 520/521 printers. For the best results, use genuine Okidata ribbons, Part No. 52107001.

 **Caution!** *If you are replacing the ribbon, the printhead may be **HOT!***

1. With the access cover open, slide the printhead (1) to the center of the platen.

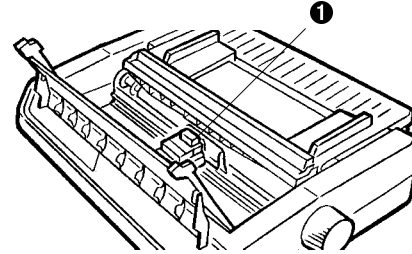

-  If you're replacing the ribbon, lift up the cartridge at the end nearest the platen, then remove and discard it.

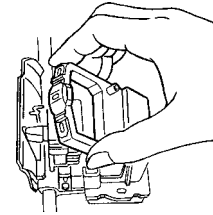

2. Remove the new ribbon cartridge from its packaging.

! *Leave the ribbon shield on the cartridge!*

3. Holding the ribbon cartridge with the knob (2) facing up and the ribbon shield (3) facing the platen, fit the grooves on either side at the back end of the cartridge over the pins on the ribbon plate (4).

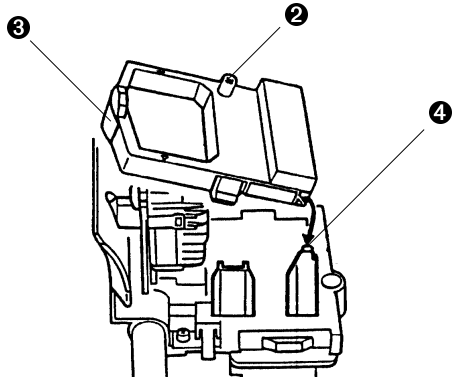

4. Lower the front of the cartridge over the printhead until it snaps into place, then turn the knob (2) in the direction of the arrow (clockwise) to take up the ribbon slack.

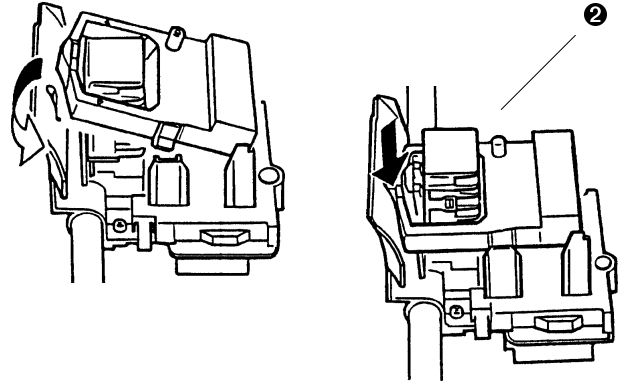

Connect to Power and Computer

- ✓ You must supply the cable for connecting your printer to your computer. A *shielded* cable is required in order to ensure compliance of this equipment with FCC regulations.
 - ✓ These instructions are for the standard parallel interface. If you have the optional serial interface, see the instructions included with it.
1. Make sure both the printer and the computer are *off*.
 2. Plug the power cord into the back of the printer.

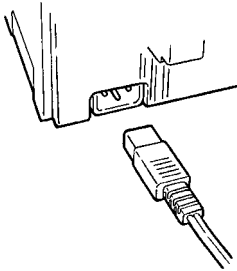

3. Plug the other end into a 120-volt, grounded outlet.

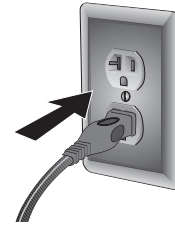

4. Plug the interface cable into the parallel port on the back of the printer, and secure it in place with the wire loops (1).

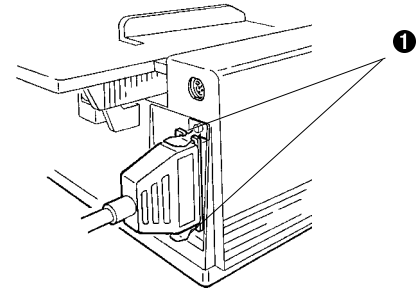

5. Turn the computer back on.

Power Up

Turn the printer on:

- The printhead will cross back and forth along the platen, and the pins will gently fire to determine the printhead gap setting.
- The POWER light will come on.
- The ALARM light will also come on, but don't be concerned: it's just telling you that there is no paper loaded.

Load Paper

Your printer has provision for

- Single sheets (top feed)
- Continuous-forms (rear feed)

You can also install options:

- Cut Sheet Feeder (top feed) — holds 100 sheets
 - Push and/or Pull Tractors for bottom feed of continuous forms, including
 - labels
 - heavy card stock
 - multi-part forms
- ✓ See the instructions provided with the options for information on installing them and on loading paper with the option installed.

Your printer's innovative, "smart" printhead automatically detects and adjusts to the thickness of the paper you're using, so you don't have to fuss with setting the printhead gap when you change the type of paper or print path you're using.

See Appendix A for more details on the types and sizes of print media you can use with your printer.

Loading Rear-Feed Paper

The rear-feed path is recommended for printing reports, etc., on single-thickness, continuous fan-fold paper. For graphics or charts, it's best to use the single-sheet paper path.

✓ If you have any paper in the paper path, be sure to remove it from the path before installing rear-feed paper!

1. Move the paper lever to the position marked "REAR".

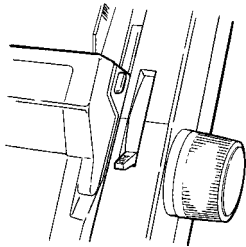

2. Grasp the front edge of the paper separator (❶) and pull it up to access the tractors.

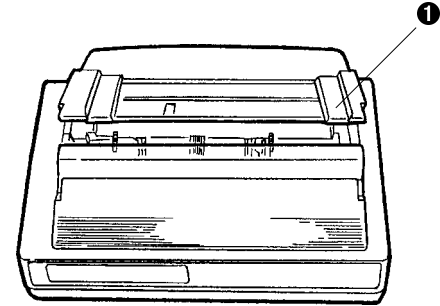

3. Pull up on the tractor lock levers (❷) to release them, then open the tractor covers (❸).

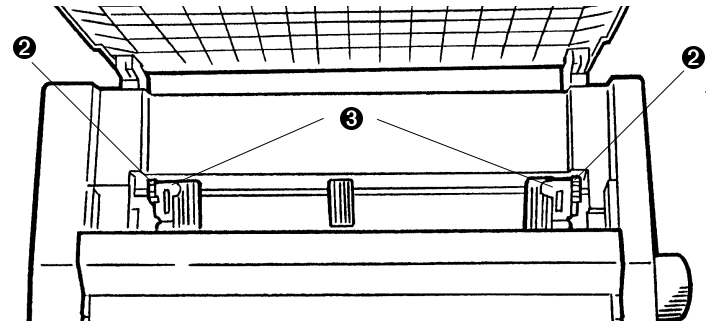

4. Position the right-hand tractor for the width of the paper you're loading, then pull the paper through the opening between the printer and the rear cover, and place the first two holes on each side over the tractor pins (4). Please note that an equal number of paper holes must be engaged on either tractor in order to ensure proper paper feed.

✓ The movement of the left tractor is limited to ensure that the paper will always contact the paper sensor when loaded.

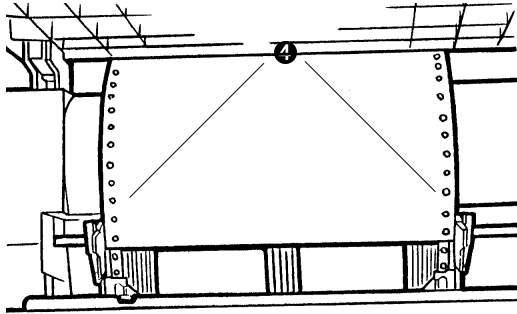

5. Close the tractor covers and adjust the left tractor to position the edge of the paper: reference marks (5) on the printer indicate the left edge position for the two most common paper sizes.

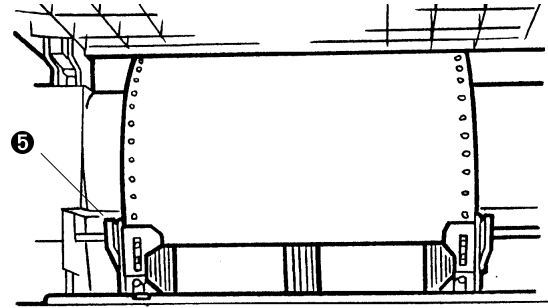

6. Lock the left tractor in place by pushing back on the lock lever (6).

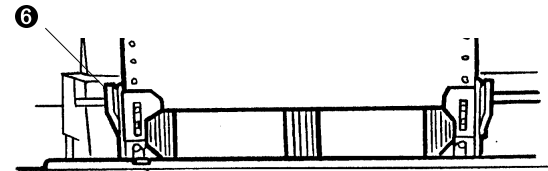

7. Adjust the right tractor so that the paper holes are centered on the pins (careful—if paper is stretched too tight or left too loose, it can jam and cause problems), then lock the right tractor in place by pushing back on the lock lever (7).

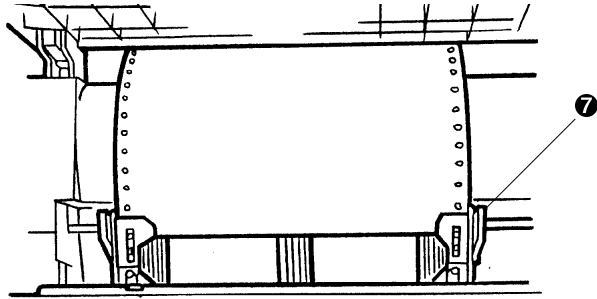

8. Close the paper separator and flip the wire feed guide over onto the pull-up roller assembly.

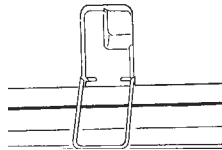

- ✓ The wire feed guide keeps paper from curling back into the printer.

9. Push the FF/LOAD button. The paper will automatically feed into the printer and the ALARM light will go out. The printhead moves back and forth, gently firing the pins to sense the paper thickness and set the printhead gap.
10. Check the baseline for the Top of Form (TOF), indicated by the red line on the clear plastic paper shield (8). If it's OK, press the SEL button and you're ready to start printing. If it needs adjustment, set the Top of Form following the instructions on page 12.

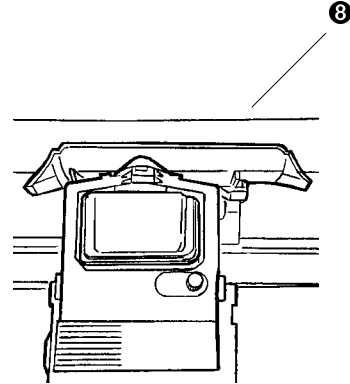

Loading Single-Sheet Paper

The single-sheet path is best for letterhead stationery, memos, and envelopes and is recommended for printing graphs and charts because it provides the most accurate control of the paper.

! *If you have any continuous-form paper in the paper path, you must press the PARK button on the front panel to remove it from the path before loading single sheets.*

1. Make sure the printer is turned ON and deselected (SEL light off—press SEL button to deselect if necessary).

✓ The ALARM light will remain on until paper is loaded.

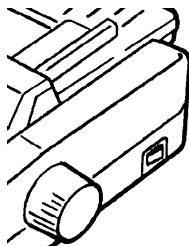

2. Move the paper lever to the position marked “TOP”.

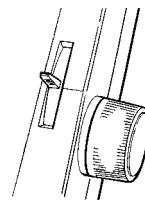

3. Grasp the back of the paper separator and unsnap it from the housing, then swing it up into the single-sheet feed position, making sure that the wire feed guide (1) is nestled in the separator.

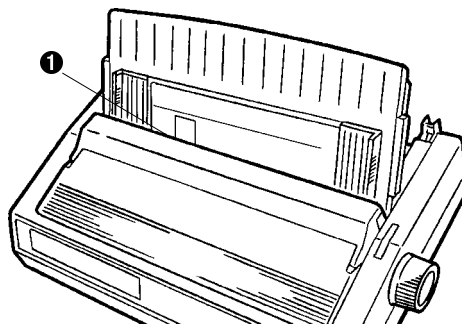

- Adjust the paper feed guides (2) for the width of the paper and drop a sheet of paper into the separator.

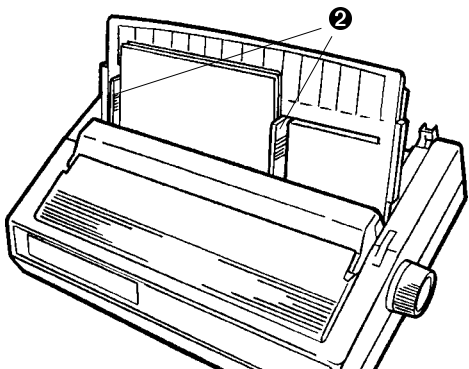

The paper will automatically feed into the printer, and the printhead will move back and forth, gently firing the pins to sense the paper thickness and set the printhead gap.

- ✓ If the paper doesn't feed in properly, the "15" light on the control panel will begin flashing. To correct this, press the SHIFT and RESET buttons simultaneously, then reload the sheet.

- Check the baseline for the Top of Form (TOF), indicated by the red line on the clear plastic paper shield (4).

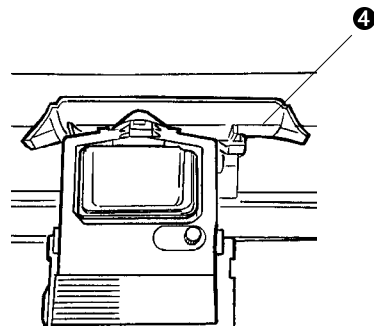

If it's OK, press the SEL button and you're ready to start printing. If it needs adjustment, set the Top of Form following the instructions on the next page.

Set the Top of Form

The red line (❶) on the clear plastic paper shield shows the baseline of the current printing position to help you place the top of form.

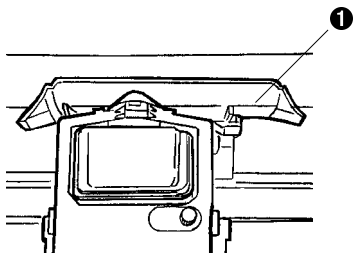

To set the Top of Form:

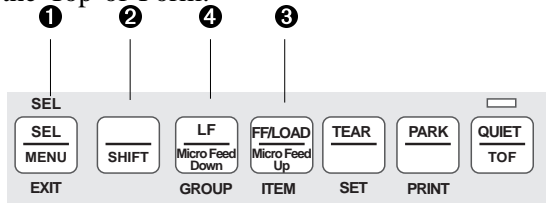

1. Make sure the printer is deselected (SEL light off—if necessary, press SEL (❶) button to deselect printer).
2. Hold down the SHIFT button (❷) and press:
 - FF/LOAD button (❸) to move the paper up in micro increments (TOF lower on page), or
 - LF button (❹) to move the paper down in micro increments (TOF higher on page).

When you're done setting the TOF, press the SEL button

(❶) to reselect the printer.

Temporarily Changing the Print Start Position

To place the print start position lower *for one page only*:

1. Press SEL to deselect the printer.
2. Keep pressing the LF button until the red line on the paper shield reaches the new position.

Resetting Top of Form to Default



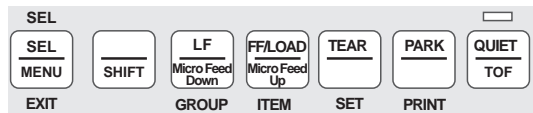

To reset the Top of Form to the factory default, turn off the printer, then hold down the QUIET and PARK buttons while turning the printer back on.



Run the Self Tests

After you've installed ribbon and paper, you are ready to run the self tests. Do this any time you want to make sure the printer is functioning properly.

! *For wide carriage Model 521, be sure you have wide paper loaded!*

Font Sample Test	Rolling ASCII Test
<p><i>To run the test:</i></p>  <p>Turn the printer off, then press and hold the LF key while turning the printer back on.</p>	<p><i>To run the test:</i></p>  <p>Turn the printer off, then press and hold the QUIET key while turning the printer back on.</p>
<p><i>To stop the test before it finishes:</i></p>  <p>Press SEL.</p>	<p><i>To stop the test:</i></p>  <p>Press SEL.</p>

Selecting an Emulation

Your printer has three emulations:

- IBM Proprinter III (factory default)
- Epson FX
- Okidata Microline Standard

Changing Emulations

Your printer is set at the factory for the IBM Proprinter III emulation. To change the emulation:

1. Enter the Menu mode by holding the SHIFT button while pressing the SEL button. The following line will print:
`Printer Control Emulation Mode IBM PPR`
2. Press the SET button until the emulation you wish to select prints.
3. Exit the Menu and save your setting by holding the SHIFT button while pressing the SEL button.

Selecting a Printer Driver

The drivers in the table below are listed by decreasing compatibility with your printer: *use one as close to the top of the list as possible*. If your software does not have a printer driver from near the top of the list, call the manufacturer to see if they have added any drivers to those supplied when you purchased your software.

- ✓ See your software documentation for instructions on how to install a printer driver.

Printer Drivers

IBM Proprinter III Emulation

Okidata ML 520/1 IBM
IBM Proprinter III
IBM Proprinter II
IBM Proprinter
IBM Graphics Printer

Epson FX Emulation

Okidata ML 520/1 Epson
Epson FX850/1050
Epson FX86/286
Epson FX
Epson EX800/1000

Okidata Microline Standard Emulation

Okidata Microline 520/521
Okidata Microline 320/321
Okidata Microline 292/293
Okidata Microline 192/193
Okidata Microline 182/183

Okidata Drivers

Okidata drivers are available for a variety of operating systems.

You can obtain the drivers by downloading them from the web site at

► <http://www.okidata.com>

Section 2: Maintaining Your Printer

Replacing the Ribbon Cartridge

To replace the ribbon cartridge, see “Install (or Replace) the Ribbon Cartridge” in Section 1. For the best results, use genuine Okidata ribbons, Part No. 52107001.

Clearing Paper Jams

! *Always turn the printer off before you turn the platen knob!*

Clearing Rear Feed Jams

To clear a rear-feed paper jam:

1. Turn off printer then turn the platen knob to back the paper out of the printer.
2. Remove any ripped pieces of paper.
3. Reload the paper, turn the printer back on and press the FF/LOAD button.

Correcting for Continuing Rear-Feed Jams

If the paper keeps jamming, you probably have bits of paper stuck in the paper path.

1. Turn off the printer.
2. Use the platen knob to back the paper out.
3. Open the access cover and lift off the pull-up roller assembly.

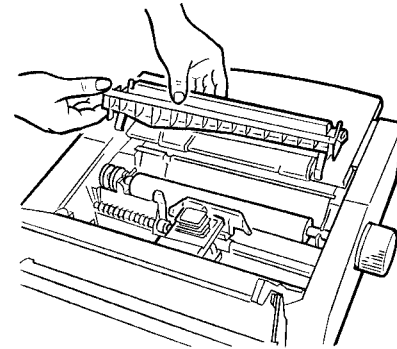

4. Lift the paper separator, open the tractors and remove the paper.

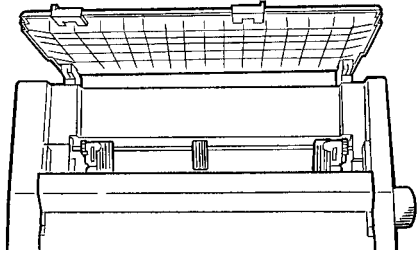

5. Fold some continuous-feed paper over three times to make a page four sheets thick and load it on the tractors. Use the platen knob to draw the sheet around the platen: this brings any jammed bits of paper out.

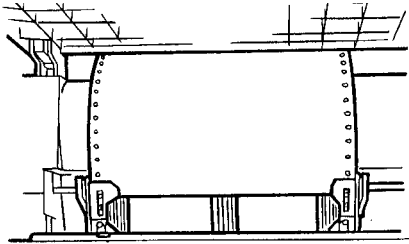

6. Back the sheet out.
7. Replace the roller assembly.
8. Reload regular paper.
9. Close the access cover.
10. Turn the printer on.
11. Press the FF/LOAD button.

Clearing Single Sheet Feed Jams

1. Turn the printer off.
2. Rotate the platen knob to back the jammed paper out of the carriage.
3. If necessary, open the access cover and lift off the pull-up roller assembly to provide access to remove any ripped pieces from around the carriage.

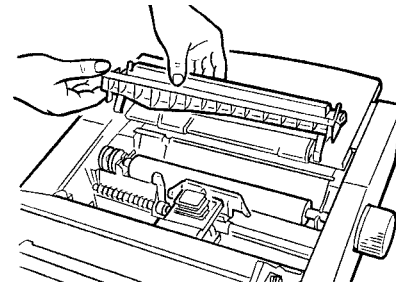

Cleaning the Housing

You should clean the printer every six months (or after about 300 hours of operation).

1. Turn the printer OFF.
2. Remove the paper from the path.
3. Open the access cover and remove the pull-up roller assembly.

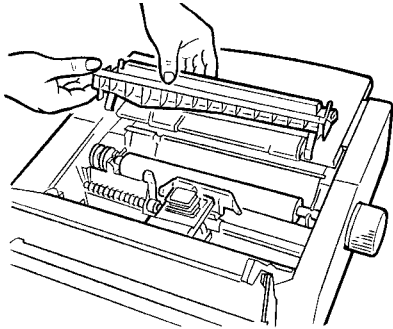

4. Use a clean, dry cloth to dust the area around the carriage shaft and platen. Be sure to remove any loose particles of paper.

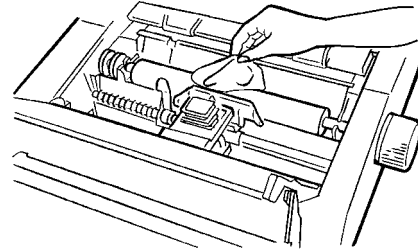

5. Reinstall the pull-up roller assembly.
6. Close the access cover.

! *Never use solvents or strong detergents on the cabinet — they could damage the housing.*

Section 3: Using Your Printer

Control Panel Indicator Lights

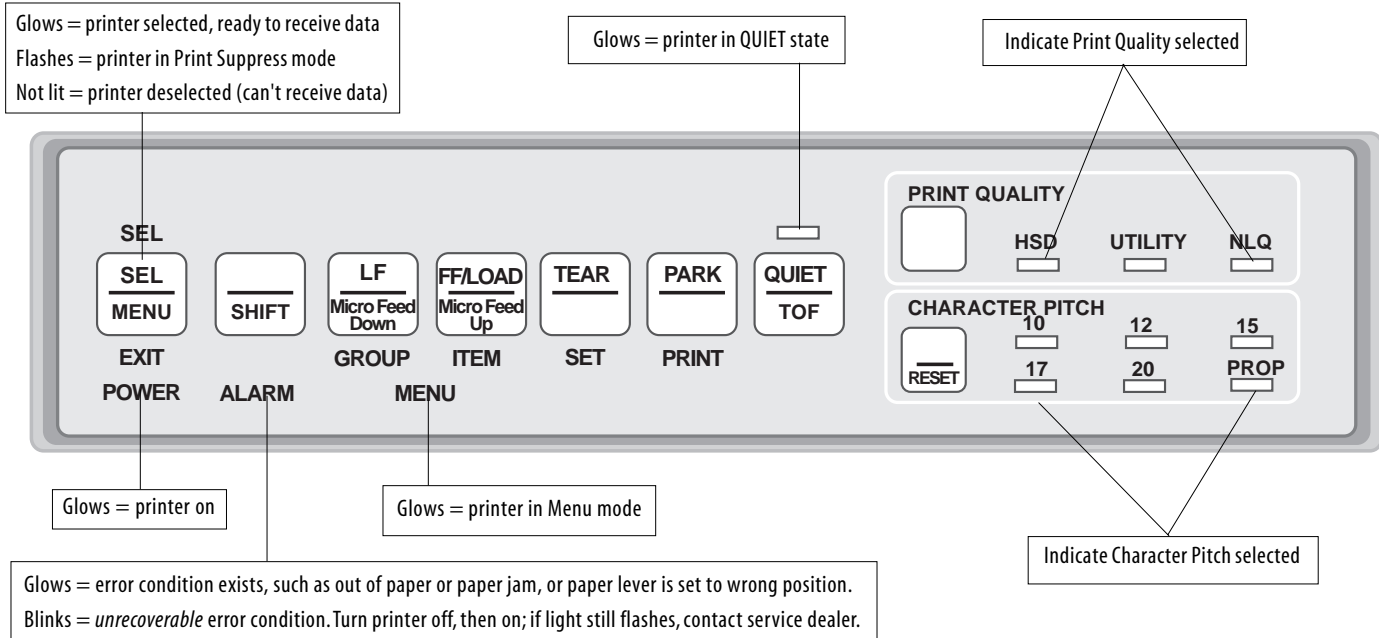

Control Panel Buttons: Print Mode

Press to select (SEL glows)/deselect printer.
 Press to reset paper alarm (ALARM glows).
 Press to end printer tests.
 Press with SHIFT to enter Menu mode.

Moves continuous-form paper up for
 tear-off or back down for printing.

Press to move paper up a line.
 Hold for repetitive line feeds.
 Hold on power up to start Font test.

Press to turn Quiet mode On (light glows) and Off.
 Printer deselected and no paper loaded: press with
 SHIFT button to reset TOF to default
 Hold on power up to start Rolling ASCII Test.

Press to set print quality, indicated
 by lights (HSD, UTILITY, NLQ).

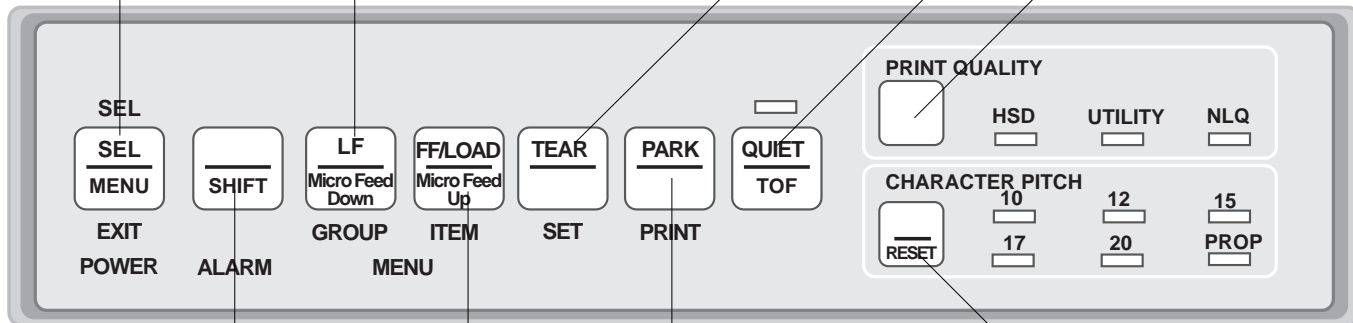

Used with other buttons to set TOF.
 Press with SEL to enter Menu mode.

Retracts continuous-form paper from path.

Press to load/eject single sheet, or to move continuous-form paper to print position.
 Printer deselected: press with SHIFT to move TOF down.

Press to set character pitch, indicated
 by lights (10, 12, 15, 17, 20, PROP).

Control Panel Buttons: Menu Mode

Press to reset paper out alarm.
Press with SHIFT button to exit Menu mode.
Press and hold with LF button on power up to reset Menu to factory defaults.

Press to advance to next setting for the Item.

Press and hold with SHIFT button to print out listing of all Menu settings, regardless of emulation or options engaged.

Press to advance to next Group in Menu.
Press with SHIFT button to go back to previous Group in Menu.

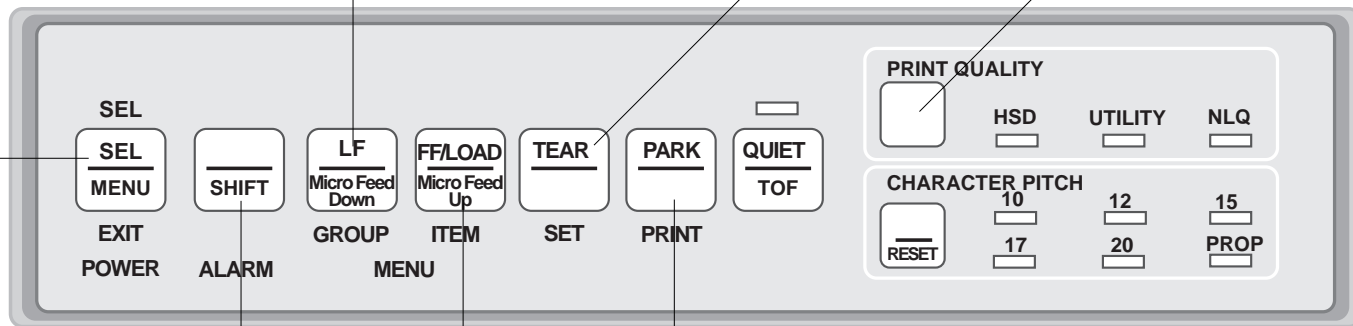

Press with SEL button to exit Menu mode.

Press to print list of current Menu settings.
Press with SHIFT button to print out current Group Menu settings.

Press to advance to next Item within a Group.
Press with SHIFT button to go back to previous Item in the Group.

Print Mode

The seven buttons to the left on your control panel are multi-function buttons. In the print mode, they are used to manipulate the paper (see the illustration on the first page of this chapter).

The PRINT QUALITY and CHARACTER PITCH buttons on the right side of the control panel are used to select the quality and size of the printing.

- ✓ The print quality and character pitch set by means of the front panel can be overridden by commands sent by the commercial software package from which you're printing a document. If you run into this problem, see page 38? for information on how to correct it.

Selecting Print Quality

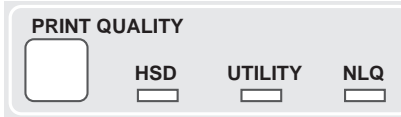

Press the PRINT QUALITY button successively until the light underneath the print quality you wish to engage is lit:

Print Quality	HSD	UTILITY	NLQ
Typeface	Gothic	Gothic	Courier or Gothic
Print Speed	Fastest	Fast	Slowest
Quality	Lowest	Medium	Highest
Used for	Data reports on continuous forms paper	Rough drafts, internal memos	Correspondence, documents requiring a polished appearance

- ✓ Your printer also prints bar codes accessible through printer commands. The Microline Reference Manual provides complete lists of all the commands, along with information on their use. You may view this document by accessing it on the CD provided with your printer.

Selecting Character Pitch

- ✓ If the SI command is received from your software, the character pitch selected on the control panel will be overridden by the SI command.

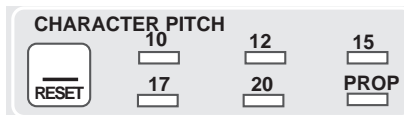

Character pitch determines the width of the individual characters and is measured in characters per inch (cpi). Press the CHARACTER PITCH button successively to page through the possible selections.

Epson and IBM emulations — 10 cpi, 12 cpi, 15 cpi, 17 cpi, 20 cpi, or Proportional. The lights indicate which pitch is selected.

Okidata Microline Standard emulation — 10, 12, 15, 17, or 20 cpi, either non-proportional or proportional: proportional is selected when both the light under the desired cpi and the light under PROP are lit.

To reset the character pitch to the factory default (10 cpi), make sure the printer is deselected (SEL light out), then hold the SHIFT button while pressing CHARACTER PITCH button.

Available Fonts

Typeface	Spacing
NLQ Courier Proportional	10 cpi*, 12 cpi, 15 cpi, 17 cpi, 20 cpi,
NLQ Letter Gothic	10 cpi*, 12 cpi, 15 cpi, 17 cpi, 20 cpi, Proportional
Utility (Gothic)	10 cpi*, 12 cpi, 15 cpi, 17 cpi, 20 cpi, Proportional
High Speed Draft (Gothic)	10 cpi*, 12 cpi, 15 cpi, 17 cpi, 20 cpi
Bar Code**	Code 39, UPC A, UPC E, EAN 8, EAN 13, Interleaved 2 of 5, Code 128, Postnet

* cpi = characters per inch

** Bar codes are available only through appropriate software packages or through programming.

Menu Mode

When your printer is in the Menu Mode, you can use the front panel controls to change the defaults for the printer parameters, including emulation, page length, line spacing, typeface, pitch, etc. The changes you make in the Menu Mode will automatically be saved in your printer's memory when you exit the Menu Mode and will be retained even if you turn the printer off.

 *If you are in the Menu Mode and turn the printer off without first exiting, any changes you have made in the menu will be lost.*

Entering The Menu Mode

To place your printer in the Menu Mode hold the SHIFT button while pressing the SEL button. The MENU light will come on and, if the printer was selected, the SEL light will go out.

Exiting The Menu Mode

To exit the Menu Mode, hold the SHIFT button and press the SEL button. The MENU light will go out and the SEL light will come on.

Resetting The Menu

To reset the Menu to the factory defaults, turn the printer off, then hold the SEL and LF buttons while turning it back on.

Printing Out the Menu

To print out the menu settings engaged, enter the Menu Mode, then press the PRINT button.

Sample Default Menu Printout

Printer Control	Emulation Mode	IBM PPR
Font	Print Mode	Utility
Font	Pitch	10 cpi
Font	Proportional Spacing	No
Font	Style	Normal
Font	Size	Single
Symbol Sets	Character Set	Set I
Symbol Sets	Language Set	American
Symbol Sets	Zero Character	Slashed
Symbol Sets	Code Page	USA
Rear Feed	Line Spacing	6 LPI
Rear Feed	Form Tear-Off	Off
Rear Feed	Skip Over Perforation	No
Rear Feed	Page Length	11"
Rear Feed	Gap Control	Auto Gap
Bottom Feed	Line Spacing	6 LPI
Bottom Feed	Form Tear-Off	Off
Bottom Feed	Skip Over Perforation	No
Bottom Feed	Page Length	11"
Bottom Feed	Gap Control	Auto Gap
Top Feed	Line Spacing	6 LPI
Top Feed	Bottom Margin	Valid
Top Feed	Page Length	11"
Top Feed	Gap Control	Auto Gap
Top Feed	Wait Time	1 sec
Set-Up	Graphics	Uni-directional
Set-Up	Receive Buffer Size	64K
Set-Up	Paper Out Override	No
Set-Up	Print Registration	0
	-(FWD)-	
	-(REV)-	
Set-Up	Operator Panel Function	Full Operation
Set-Up	Reset Inhibit	No
Set-Up	Print Suppress Effective	Yes
Set-Up	Auto LF	No
Set-Up	Time Out Print	Valid
Set-Up	Auto Select	No
Set-Up	Printhead Gap Adjust	0
Parallel I/F	I-Prime	Buffer Print
Parallel I/F	Pin 18	+5v

Summary of Menu Settings

The table below details all possible entries in the printer Menu. The defaults are in bold italics. Explanations for each item (in alphabetical sequence) follow the table.

Group	Item	Settings
Printer Control	Emulation Mode	IBM PPR, Epson FX, ML
Font	Print Mode	Utility, NLQ Courier, NLQ Gothic, HSD
	Pitch	10 cpi, 12 cpi, 15 cpi, 17.1 cpi, 20 cpi
	Proportional spacing	No, Yes
	Style	Normal, Italics
	Size	Single, Double
Symbol Sets	Character Set	Set I, Set II
	Language Set	American, French, German, British, Danish I, Swedish, Italian, Spanish I, Japanese, Norwegian, Danish II, Spanish II, Latin American, French Canadian, Dutch, Publisher
	Zero Character	Slashed, Unslashed
	Code Page	USA, Canada French, Multilingual, Portugal, Norway
Rear Feed	Line Spacing	6 LPI, 8 LPI
	Form Tear-Off	Off, 500ms, 1 sec, 2 sec
	Skip Over Perforation	No, Yes

Group	Item	Settings
Rear Feed (cont.)	Page Width*	13.6", 8"
	Page Length	11", 11-2/3", 12", 14", 17", 3", 3.5", 4", 5.5", 6", 7", 8", 8.5"
	Gap Control	Auto Gap, Semi Auto Gap, 1, 2, 3, 4, 5, 6, 7, 8, 9
Bottom Feed **	Line Spacing	6 LPI, 8 LPI
	Form Tear-Off	Off, 500ms, 1 sec, 2 sec
	Skip Over Perforation	No, Yes
	Page Width*	13.6", 8"
	Page Length	11", 11-2/3", 12", 14", 17", 3", 3.5", 4", 5.5", 6", 7", 8", 8.5"
	Gap Control	Auto Gap, Semi Auto Gap, 1, 2, 3, 4, 5, 6, 7, 8, 9
Top Feed	Line Spacing	6 LPI, 8 LPI
	Bottom Margin	Valid, Invalid
	Page Width*	13.6", 8"
	Page Length	11", 11-2/3", 12", 14", 17", 3", 3.5", 4", 5.5", 6", 7", 8", 8.5"
	Gap Control	Auto Gap, Semi Auto Gap, 1, 2, 3, 4, 5, 6, 7, 8, 9
	Wait Time	500 ms, 1 sec, 2 sec

* Model 521 only

** Applicable only when optional Bottom-Feed Push Tractor is installed.

Group	Item	Settings
Set-Up	Graphics	Uni-directional, Bi-directional
	7 or 8 Bit Graphics‡	8, 7
	Receive Buffer Size	64K, 1 Line, 32K
	Paper Out Override	No, Yes
	Print Registration	0, 0.05 mm Left, 0.10 mm Left, 0.15 mm Left, 0.20 mm Left, 0.25 mm Left, 0.25 mm Right, 0.20 mm Right, 0.15 mm Right, 0.10 mm Right, 0.05 mm Right
	Operator Panel Function	Full Operation, Limited Operation
	Reset Inhibit	No, Yes
	Print Suppress Effective	Yes, No
	Auto LF	No, Yes
	Auto CR†	No, Yes
	Print DEL Code‡	No, Yes
	SI Select Pitch (10 cpi)†	17.1 CPI, 15 CPI
	SI Select Pitch (12 cpi)†	20 CPI, 12 CPI
	Time Out Print	Valid, Invalid
Auto Select	No, Yes	
Printhead Gap Adjust	0, -1, +1	

† Appears only when IBM Proprinter emulation is selected.

‡ Appears only when MICROLINE Standard emulation is selected.

Group	Item	Settings
Parallel I/F	I-Prime	Buffer Print, Buffer Clear, Invalid
	Pin 18	+5V, Open
	Auto Feed XT♥	Invalid, Valid

♥ Appears only when Epson LQ emulation is selected.

Explanation of Menu Items

These explanations are in alphabetical sequence. Line Spacing, Form Tear-Off, Skip Over Perforation, Page Length, and Gap Control appear several times in the menu.

7 or 8 Bit Graphics. Choose graphics your system uses: 7 or 8 (factory default) dots in each column printed.

Auto CR (IBM). If you wish to have the printer automatically add a carriage return when a Line Feed is received at the end of the line, change the setting to Yes.

Auto LF. If your printout is consistently double spaced, select No (factory default); if it overprints, choose Yes.

Auto Feed XT (Epson). If your system uses pin 14 of the parallel interface to control automatic line feed, change the setting to Valid.

Auto Select. With the factory default (No) engaged, the printer will remain deselected after you load in paper so that you can set the Top of Form. If you always use the same Top of Form setting, change this setting to Yes.

Bottom Margin. Change the setting to Invalid if you want printer to ignore the bottom margin setting. *Caution!! This can cause loss of data and damage the printhead.*

Character Set. Choose IBM Set I (factory default) or IBM Set II.

Code Page. Choose USA (factory default), Canada French, Multilingual, Portugal, or Norway.

Emulation Mode. Choose IBM PPR (default) for IBM Proprinter III, Epson FX, or ML for Okidata Microline Standard.

Form Tear-Off. Choose 500ms, 1 sec, or 2 sec to turn this feature on and select a time interval for the printer to wait before advancing the paper.

Gap Control. Determines how the printhead gap is set. Auto Gap automatically determines paper thickness on first page; for single sheets, it also rechecks each page while printing. Semi Auto Gap is similar; but it does not recheck single sheets while printing. You can also choose a fixed headgap setting of 1 (narrowest) to 9 (widest).

Graphics. Change to bi-directional graphics for faster printing; optimize by the Print Registration setting in the Menu.

I-Prime. Sets what the printer does when it receives the I-Prime signal from software. Buffer Print (factory default): prints out buffer contents before resetting. Buffer Clear: dumps buffer contents immediately. Invalid: ignores I-Prime signal.

Language Set. Replaces certain symbols with special characters used in the respective foreign language.

Line Spacing. Change from 6 to 8 lpi (lines per inch) to get more lines per page.

Operator Panel Function. Change to Limited Operation to deactivate PRINT QUALITY and CHARACTER PITCH buttons when several people are using the printer and you

don't want these settings changed from the control panel.

- ✓ This feature also prevents normal access to the Menu. To access the Menu, turn the printer off, then hold down the SEL key while turning the printer on.

Page Length. Selects the length of the paper you're using.

Page Width (Model 521 only). Choose 8" for letter-size paper.

Paper Out Override. Senses when less than one inch of paper remains and stops printing. Choose Yes to override the detector. *Caution!! This can cause loss of data and damage the printhead.*

Pin 18. Sets the signal on pin 18 to +5V (factory default) or Open.

Pitch. Choose character width measured in characters per inch (cpi).

Print DEL Code (MICROLINE Standard). Change to Yes if you wish to print the DEL code (decimal 127) as a solid box.

Print Mode. Choose NLQ Courier or NLQ Gothic font for letter quality printing, utility (factory default) for faster draft printing, or HSD for fastest printing (lowest quality).

Print Registration. Change the setting as required to obtain the best registration for bi-directional printing.

Print Suppress Effective. If your system uses the DC1 and DC3 codes for something other than the print suppress mode, change the setting to No.

Printhead Gap Adjust. Fine tunes the automatic setting of the printhead gap. If your printer is consistently printing too light, change the setting to -1; if it's too dark, change the setting to +1.

Proportional Spacing. Change the setting to Yes to engage proportional spacing of characters.

Receive Buffer Size. 64K (factory default), 1 Line, or 32K. Selects amount of memory devoted to holding received data. 1 Line will tie up your computer while printing, but if you abort the print job, the printer will stop printing much sooner.

Reset Inhibit. Selecting Yes prevents your software from resetting your printer's settings.

SI Select Pitch, 10 CPI (IBM only). Sets the pitch (17.1—the factory default— or 15 characters per inch) to be engaged when the printer control panel is set for 10 cpi and the SI command is received.

SI Select Pitch, 12 CPI (IBM only). Sets the pitch (20—the factory default— or 12 characters per inch) to be engaged when the printer control panel is set for 12 cpi and the SI command is received.

Size. Change to Double for double width and height printing.

Skip Over Perforation. Change to Yes if you want the printer to go to the next page when it comes within 1" of the bottom. Keep it set to No if your software has its own page formatting controls.

Style. Change to Italics if you want the printed characters to be slanted.

Time Out Print. If your software spends a long time processing between portions of data it feeds to the printer, change the setting to Invalid to keep your printer from inadvertently dumping the received data while it's waiting for more.

Wait Time. Sets the amount of time—500 ms, 1 sec (factory default), or 2 sec—the printer will wait for more data before moving to the form tear-off position.

Zero Character. If you don't wish the printer to use a slash to distinguish the number 0 from the capital letter O, change the setting to Unslashed.

Using the Printer's Features

Tear Feature

When you're using continuous forms with either the built-in rear-feed tractor or the optional bottom-feed push tractor, you can use this feature to advance the forms up to the tear position so you can easily tear off a printed sheet without wasting paper or readjusting the printer. To do this, simply press the TEAR button on the front panel.



! *The tear feature can NOT be used when the optional pull tractor is installed!*

Forms Tear-off Feature

! *Never engage Forms Tear-off when printing on labels!*

The Forms Tear-off feature automatically moves the paper up to the tear position after the selected interval. When the printer receives data, it will move down to the initial printing position.

This feature is normally turned off. To activate it:

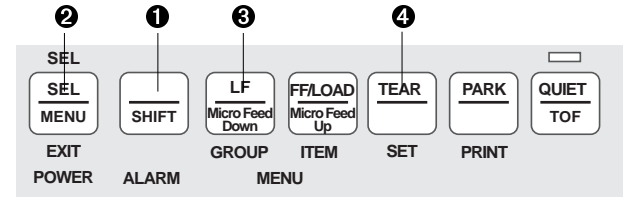

1. Hold the SHIFT button (①) and press the SEL button (②) to enter the Menu mode.
 2. Press the GROUP button (③) until the line
Rear Feed Form Tear-Off Off
prints.
 3. Press the SET button (④) until the time interval you wish to select prints .
 4. Hold the SHIFT button (①) and press the SEL button (②) to exit the Menu mode and save the setting.
- ✓ Some programs pause occasionally while sending data. If the pause lasts more than the selected interval, the paper will advance to the tear-off position until more data is received. This extra paper movement can cause uneven print registration in graphics. If you have this problem, use the menu to deactivate Forms Tear-Off.

- ✓ If you have problems setting the Top of Form high enough on the page when using Forms Tear Off, see “Problem Solving.”

Paper Park Feature

If you have continuous-form paper loaded and you wish to switch to another paper path, first tear off the printed pages, then press the PARK button. The continuous-form paper will immediately retract from the paper path.



Switching Paper Paths

To switch to single-sheet feed:

1. Tear off any printed pages, then press PARK.

2. Swing the wire guide up into the paper separator, and swing the separator upright.
3. Move the paper lever to “TOP.”
4. Load single sheet paper.

To switch to continuous-form feed:

1. Press FF/LOAD to remove single sheet from paper path if needed.
 2. Lower the paper separator and swing the wire guide out.
 3. Move the paper lever to “REAR” or “BOT,” as appropriate.
 4. Press FF/LOAD.
- ✓ When you switch paths, the printhead travels and gently fires pins to sense paper thickness and set the gap.

Section 4: Problem Solving

Problem: *Nothing happens when I turn on the printer.*

Solution: The printer may not be plugged in. Check the power cord connection to the outlet and to your printer. If you're using a power strip, make sure it's turned on. Check to be sure that the fuse hasn't blown or that the circuit breaker hasn't tripped.

Problem: *The printer doesn't print when the computer sends data.*

Solutions: (1) The printer may be deselected. If the SEL light is out, press the SEL button to select the printer.

(2) The printer cable may not be securely connected. Check the cable to be sure that it is properly connected to both the PC and the printer.

(3) If you have installed the serial I/F board, it may not be firmly seated. Check to be sure that the board is firmly seated in the printer.

Problem: *I'm getting strange symbols, incorrect fonts, etc., when I try to print a document.*

Solution: The printer driver you have engaged does not agree with the emulation selected for your printer.

To check the emulation selected, first make sure paper is loaded, then press the SEL and SHIFT buttons simultaneously to enter the MENU on your printer. Next, press the GROUP button: this will print the emulation selected.

If the emulation is not the one you want to use, press the SET button to change it to the one you want before exiting the MENU (to exit, press SEL and SHIFT buttons).

If the emulation is correct, check your software documentation on how to select a printer driver, then check to be sure that you have selected one of the drivers listed for that emulation in Section 1. The closer the driver is to the top of the list, the more compatible it will be with your printer. If your software doesn't have any of the indicated drivers available, check with the software manufacturer to see if they have added any additional drivers since you purchased your software.

If you have embedded any printer commands in your software, check to be sure that you entered them correctly.

Problem: *I've installed a brand new ribbon and the printing is smeared and streaked.*

Solution: The plastic ribbon shield is either loose or missing. The shield must be left on the ribbon when you are installing the cartridge. To remedy this situation, (caution—printhead may be HOT!) move the printhead to the center of the platen and lift off the ribbon cartridge. If the ribbon shield is loose, secure it in place properly. If it's missing, locate it and reinstall it.

Problem: *I see printing on the right side of the page which is lighter or darker than the rest of the print.*

Solution: Although the printer automatically sets the head gap, it may sometimes need minor adjustment. To do this:

1. Hold SHIFT button and press SEL button to enter Menu mode.
2. Press GROUP button until Setup group prints.
3. Press ITEM button until Printhead Gap appears.
4. Press SET button to change setting. The default setting is 0. If the printing is sometimes lighter, change the setting to -1; if it's sometimes darker, change it to +1.
5. Hold SHIFT button and press SEL button to save setting and exit Menu mode.

Problem: *The Alarm light is on and the Character Pitch 15 light is flashing.*

Solution: This indicates a paper loading error. To stop the flashing light, press the SEL button. Before trying to load paper again, check to be sure that the paper lever is in the correct position (BOT, TOP, REAR) for the path you're using.

If the paper lever is in the correct position and you're using rear feed, lift up the paper separator and check to be sure that the paper is properly on the tractors and has not jammed up somehow.

If the paper lever is in the correct position and you're using the optional bottom-feed push tractor, check the bottom tractor unit to be sure that the paper is properly on the tractors and has not jammed up before entering the printer.

Once the paper is correctly loaded, press and release the SEL button, then hold the SHIFT button and press the RESET (Character Pitch) button.

Problem: *The first line is printing too far down on the page and I can't get it any higher using the SHIFT and LF/Micro Feed Down buttons.*

Solution: The setting for the Top of Form (TOF) will be restricted if you have the Forms Tear-Off feature engaged when you set the TOF. To correct for this, you must reset the TOF with the Forms Tear-Off disengaged, as follows:

1. Hold SHIFT button and press SEL button to enter Menu mode.
2. Use GROUP and ITEM buttons to reach Rear Feed Form Tear-Off entry and/or Bottom Feed Form Tear-Off entry, depending on paper path(s) you're using.
3. Use SET button to change Form Tear-Off setting to Off.
4. Hold SHIFT button and press SEL button to exit Menu mode.
5. Press SEL button to deselect printer.
6. Hold SHIFT button while pressing LF/Micro Shift Down button to set TOF at desired position.
7. Hold SHIFT button and press SEL button to enter Menu mode.
8. Use GROUP and ITEM buttons to reach Rear Feed Form Tear-Off entry and/or Bottom Feed Form Tear-Off.
9. Use SET button to change Form Tear-Off to desired setting (500ms, 1 sec or 2 sec).

10. Hold SHIFT button and press SEL button to exit Menu mode.

Problem: *I need to load paper, but the Alarm light is not on and I can't load paper.*

Solution: If the Alarm light is off, the printer thinks it has paper loaded. To correct this problem, press and release the SEL button, then hold the SHIFT button and press the RESET (Character Pitch) button. The Alarm light will come on and you'll be able to load paper.

Problem: *My word processor files don't print the way I have the MENU and front panel set.*

Solution: Before sending a file to the printer, many word processors send either an "initialization string" or an I-Prime signal to the printer.

The initialization string contains codes that reset the printer to a default set of features: otherwise the printer might accidentally print using features set for a previous job. These codes override panel or MENU settings. To set your printer to ignore the reset code, enter the printer MENU (hold SHIFT button while pressing SEL/MENU button) and change the Reset Inhibit item (in the Set-Up group) to Yes. Please note that while this will stop the reset code from resetting your printer, other codes in the

initialization string may still override the printer MENU and/or front panel settings.

The I-Prime signal is sent over the parallel interface (pin 31) and will automatically override any settings you have made using the front panel buttons. To eliminate this problem, enter the program MENU (hold SHIFT button while pressing SEL/MENU button) and change the I-Prime item (in the Parallel I/F group) to Invalid.

Problem: *The Print Quality and Character Pitch buttons on the front panel won't work.*

Solution: The Operator Panel Function item on the printer MENU can be used to disable these buttons. If the printer is part of a customized system or if it is used by a number of people, the system manager may have used this option to make sure the printer is always set properly.

Problem: *Static electricity causes the paper to stick.*

Solution: In cold, dry weather, static charges can build up on continuous-form paper. This can make the paper cling to the paper separator. If you have this problem during high-volume printing jobs, try moving the single sheet paper guides on the separator together so that the paper rests on the guides rather than on the separator itself.

Section 5: Specifications

Print Method: Impact dot matrix

Printhead: 9 pins, 0.34 mm diameter, automatically adjusting to paper thickness, with thermal protection

Print Speed

<i>Mode</i>	<i>Characters per second at 10 Cpi</i>
High Speed Draft (HSD)	427 cps
Utility	320 cps
Near Letter Quality (NLQ)	80 cps

Characters per Line (CPL)

<i>Setting</i>	<i>ML520</i>	<i>ML521</i>
10 cpi	80 cpl	136 cpl
12 cpi	96 cpl	163 cpl
15 cpi	120 cpl	204 cpl
17.1 cpi	137 cpl	233 cpl
20 cpi	160 cpl	272 cpl

Emulations: Epson FX, IBM Proprinter, and Okidata Microline Standard co-resident

Interface: *Standard:* Centronics parallel
Optional: RS-232C serial

Graphics Resolution

<i>Emulation</i>	<i>Resolution</i>
Epson/IBM	Single Density: 144 × 240 dpi Double Density: 120 × 144 dpi Quadruple Density: 72 × 120 dpi
Okidata MICROLINE Standard	Single Density: 144 × 288 dpi Double Density: 144 × 144 dpi Quadruple Density: 72 × 72 dpi

Resident Fonts

<i>Print Quality</i>	<i>Available Fonts</i>
Near Letter Quality	Courier, Gothic
Utility	Gothic
High Speed Draft	Gothic

Bar Codes: Code 39, UPC A, UPC E, EAN 8, EAN 13,
Interleaved 2 of 5, Code 128 (A, B, C),
Postnet

Receive Buffer Size: 64K

Reliability

<i>Parameter</i>	<i>Reliability</i>
Mean Time Between Failures (MTBF)	6000 hours at 25% duty cycle and 35% page density
Mean Time to Repair (MTTR)	15 minutes
Printhead life	200 million characters average in 10 cpi utility mode at 25% duty and 35% page density
Ribbon Life (on average, 10 cpi utility)	4 million characters

Paper Width: *Minimum:* 3"

Maximum: Model 520, 10"
Model 521, 16"

Paper Weight: 12 to 24 lb.

Paper Thickness: *Rear feed:* 0.014" (0.36 mm)
Bottom feed: 0.017" (0.44 mm)

Paper Specifications

<i>Paper Type</i>	<i>Feed</i>	<i>Weight</i>	<i>Width Range*</i>
Cut sheets	Top only	14 to 24 lb.	NM: 7.2 to 8.5" WM: 7.2 to 14.3"
Single-part continuous forms	Rear, Bottom	12 to 24 lb.	NM: 3 to 10" WM: 3 to 16"
Carbonless, continuous forms (orig. + 5 copies)	Rear, Bottom	9 to 11 lb.	NM: 3 to 10" WM: 3 to 16"
Interleaf, continuous forms (orig + 5 copies)	Rear, Bottom	10 to 12-lb. paper, 9-lb. carbon	NM: 3 to 10" WM: 3 to 16"
Labels	Bottom only	N.A.	NM: 3 to 10" WM: 3 to 16"
Envelopes, single feed	Top only	24 lb. max	6.5 to 9.5"
Envelopes, continuous feed, non-overlap type	Bottom only	24 lb. max	6.5 to 9.5"
Card stock	Bottom only	120 lb. max.	N.A.
Transparencies	Top only	—	8.5 to 11"

* NM = Model 520; WM = Model 521

Dimensions (W × D × H)

Model 520: 17 × 15 × 6½ inches
(431 × 380 × 166 mm)

Model 521: 23 × 15 × 6½ inches
(585 × 380 × 166 mm)

Weight

Model 520: 17lb. 10oz. (8 kg)

Model 521: 23lb. 2oz. (10.5 kg)

Environmental Requirements

<i>Parameter</i>	<i>Range</i>
Operating Temperature	41 to 104°F (5 to 40°C)
Storage Temperature	14 to 122°F (-10 to +50°C)
Operating Humidity	20 to 80% RH
Storage Humidity	5 to 95% RH

Electrical requirements: 120 volts ac (+5.5%, ±15%),
60 Hz (±2%)

Also available for 230 volts
ac (+6%, -10%) or 240
(+10%) volts ac, 50/60 Hz
(±2%)

Specifications subject to change without notice.

Section 6: Parts & Accessories

How to Order Parts

Before you order, make sure you know your printer model number (on the front of the unit) and have the correct part number and description of the item. For your convenience, the most commonly used items are listed below.

Ways to Purchase Replacement Parts

- Consult the dealer where you purchased your printer.
- Consult an Okidata Authorized Sales or Service Dealer. (To locate an Authorized Okidata Sales or Service Dealer, visit <http://www.okidata.com>.)
- In the United States, purchase directly from Okidata:
 - Via the internet at <http://www.myokidata.com>
 - Order toll-free by phone at 1-800-OKI-DATA (1-800-654-3282), using VISA, MasterCard, or American Express.
- In Canada, call 888-309-4570.

Replacement Parts

Replacement Part	Order No.
AC Cord ❶	56609701
Access Cover ❷	
Model 520	53067101
Model 521	53067201
Platen Knob ❸	53562601
Printhead ❹	50099501
Pull-up Roller Assembly ❺	
ML520	53341501
ML521	53341601
Ribbon ❻	52107001

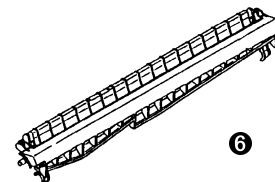
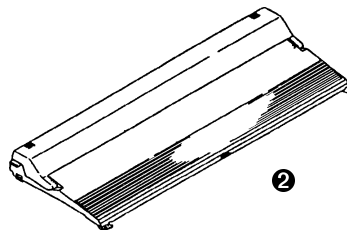
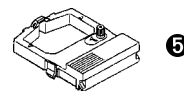
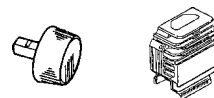
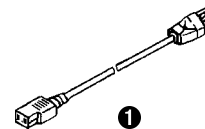

Manuals

Manual	Order No.
Maintenance Manual	59258401

Accessories

Accessory	Order No.
<i>Model 520</i>	
Cut Sheet Feeder ❶	70022501
Dual-Bin Cut Sheet Feeder	70022601
Pull Tractor, Top-Mount ❷	70023001
Push Tractor, Bottom-Feed ❸	70022901
Roll Paper Stand ❹	70023301

<i>Model 521</i>	
Cut Sheet Feeder ❶	70022701
Dual-Bin Cut Sheet Feeder	70022801
Pull Tractor, Top-Mount ❷	70023201
Push Tractor, Bottom-Feed ❸	70023101

<i>Both Models</i>	
Serial Interface ❺	70012801

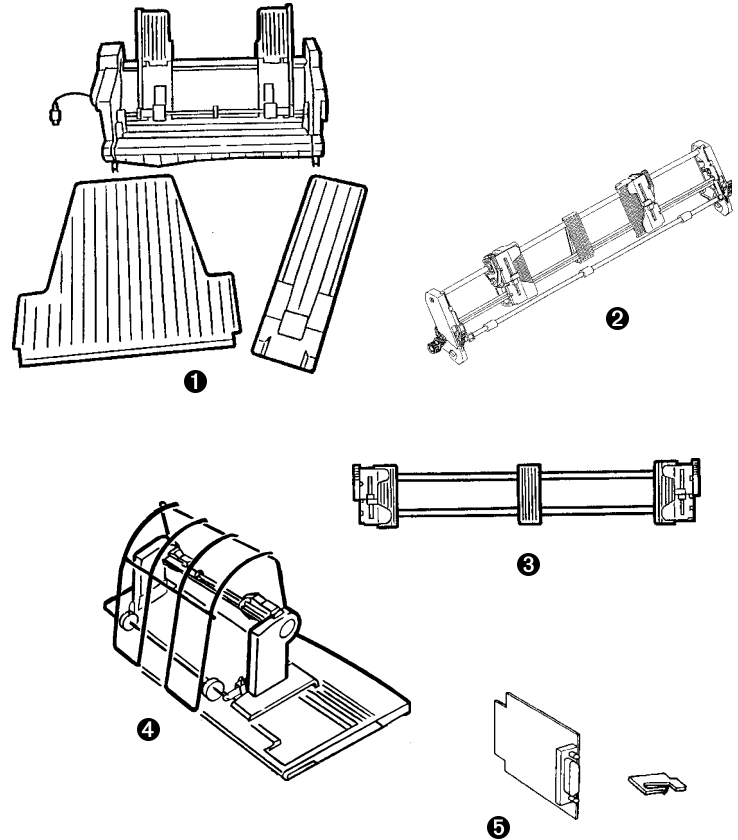

Section 7: Commands

This section contains a listing of the more commonly used commands. The Microline Reference Manual provides complete lists of all the commands, along with information on their use. You may view this document by accessing it on the CD provided with your printer.

Epson FX Commands

Epson Command	ASCII	Decimal
Backspace	BS	8
Carriage Return, Execute	CR	13
Character Pitch		
Select 10 cpi	ESC P	27 80
Select 12 cpi	ESC M	27 77
Select 15 cpi	ESC g	27 103
Select 20 cpi	ESC SI	27 15, or 15
Cancel 20 cpi	DC2	18

Epson Command	ASCII	Decimal
Delete	DEL	127
Double Height On	ESC w 1	27 119 49
Double Height Off	ESC w 0	27 119 48
Double Width On	ESC W 1	27 87 49
Double Width Off	ESC W 0	27 87 48
Double Width, One Line Only		
On	ESC SO	27 14
Off	DC4	20
Emphasized Print On	ESC E	27 69
Emphasized Print Off	ESC F	27 70
Enhanced Print On	ESC G	27 71
Enhanced Print Off	ESC H	27 72
Epson Set 1, Select	ESC t 0	27 116 48
Epson Set 2, Select	ESC t 1	27 116 49
Italic Printing On	ESC 4	27 52
Italic Printing Off	ESC 5	27 53
Form Feed	FF	12

Epson Command	ASCII	Decimal
Form Length n Inches (n = 1 to 22) n Lines (n = 1 to 255)	ESC C NUL n ESC C n	27 67 0 n 27 67 n
Horizontal Tab	HT	9
Justification		
Left	ESC a 0	27 97 48
Center	ESC a 1	27 97 49
Right	ESC a 2	27 97 50
Full	ESC a 3	27 97 51
Line Feed, Execute w/ Carriage Return n/216" (n = 0 to 255) n/144" (n = 0 to 127) Reverse, n/216" (n = 0 to 255)	LF ESC J n ESC % 5 n ESC j n	10 27 74 n 27 37 53 n 27 106 n
Line Spacing, Set n/144" (n = 0 to 127) n/216" (n = 0 to 255) n/72" (n = 0-85 or 128-213) 1/6" 1/8" 7/72"	ESC % 9 n ESC 3 n ESC A n ESC 2 ESC 0 ESC 1	27 37 57 n 27 51 n 27 65 n 27 50 27 48 27 49

Epson Command	ASCII	Decimal
Paper Out Sensor Off	ESC 8	27 56
Paper Out Sensor On	ESC 9	27 57
Print Quality/Font		
Select HSD Print Mode	ESC (0	27 40 48
Select NLQ	ESC x 1	27 120 49
Select UTL	ESC x 0	27 120 48
Print Speed		
Half-Speed On	ESC s 1	27 115 49
Half-Speed Off	ESC s 0	27 115 48
Print Suppress Mode On	DC3	19
Print Suppress Mode Off	DC1	17
Proportional Spacing On	ESC p 1	27 112 49
Proportional Spacing Off	ESC p 0	27 112 48
Reset Printer		
Clear Buffer & Initialize	ESC @	27 64
Clear Print Buffer	CAN	24
Skip Over Perforation, Cancel	ESC O	27 79
Software I-Prime	ESC } NUL	27 125 0
Subscript On	ESC S 1	27 83 49
Superscript On	ESC S 0	27 83 48
Subscript/Superscript Off	ESC T	27 84

Epson Command	ASCII	Decimal
Underline On	ESC - 1	27 45 49
Underline Off	ESC - 0	27 45 48
Uni-Directional Printing		
One Line Only	ESC <	27 60
On	ESC U 1	27 85 49
Off	ESC U 0	27 85 48
Vertical Tab, Execute	VT	11

IBM Proprinter III Commands

IBM Command	ASCII	Decimal
Backspace	BS	8
Carriage Return	CR	13
Character Pitch		
Select 10 cpi	DC2	18
Select 12 cpi	ESC :	27 58
Select 15 cpi	ESC g	27 103
Select 20 cpi	ESC SI	27 15
Select Compressed Pitch	SI	15

IBM Command	ASCII	Decimal
Character Sets		
IBM Set I	ESC 7	27 55
IBM Set II	ESC 6	27 54
Double Width On	ESC W 1	27 87 49
Double Width Off	ESC W 0	27 87 48
Double Width, One Line Only		
On	SO	27 14
Off	DC4	20
Emphasized Printing On	ESC E	27 69
Emphasized Printing Off	ESC F	27 70
Enhanced Printing On	ESC G	27 71
Enhanced Printing Off	ESC H	27 72
Form Feed	FF	12
Form Length, n inches (n = 1 to 22)	ESC C NUL n	27 67 0 n
Form Length, n lines (n = 1 to 255)	ESC C n	27 67 n
Horizontal Tab, Execute	HT	9
Italics On	ESC % G	27 37 71
Italics Off	ESC % H	27 37 72

IBM Command	ASCII	Decimal
Line Feed, Execute w/ Carriage Return n/144" (n = 1 to 127) n/216" (n = 0 to 255) Auto Line Feed On Auto Line Feed Off	LF ESC % 5 n ESC J n ESC 5 1 ESC 5 0	10 27 37 53 n 27 74 n 27 53 49 27 53 48
Line Spacing Set Spacing to 1/8" Set Spacing to 7/72" Set Spacing to n/72" (n = 0 to 255) Store Spacing Set by ESC A n Set Spacing to n/144" (n = 1 to 127) Set Spacing to n/216" (n = 0 to 255)	ESC 0 ESC 1 ESC A n ESC 2 ESC % 9 n ESC 3 n	27 48 27 49 27 65 n 27 50 27 37 57 n 27 51 n
Overscore On Overscore Off	ESC _ 1 ESC _ 0	27 95 49 27 95 48
Paper Out Sensor Off Paper Out Sensor On	ESC 8 ESC 9	27 56 27 57
Print Quality, Select HSD	ESC # 0	27 35 48

IBM Command	ASCII	Decimal
Print Suppress On, ML520 Print Suppress On, ML521 Print Suppress Off	ESC Q STX ESC Q SYN DC1	27 81 3 27 81 22 17
Proportional Spacing On Proportional Spacing Off	ESC p 1 ESC p 0	27 112 49 27 112 48
Reset: Clear Print Buffer	CAN	24
Software I-Prime	ESC } NUL	27 125 0
Stop Printing	ESC j	27 106
Subscript On Superscript On Subscript/Superscript Off	ESC S 0 ESC S 1 ESC T	27 83 48 27 83 49 27 84
Top of Form, Set at Current Position	ESC 4	27 52
Underline Printing On Underline Printing Off	ESC - 1 ESC - 0	27 45 49 27 45 48
Uni-Directional Print On Uni-Directional Print Off	ESC U 1 ESC U 0	27 85 49 27 85 48
Vertical Tab, Execute	VT	11

Okidata MICROLINE Standard Commands

Okidata Command	ASCII	Decimal
Backspace	BS	8
Carriage Return	CR	13
Character Pitch		
Select 10 cpi	RS	30
Select 12 cpi	FS	28
Select 15 cpi	ESC g	27 103
Select 17.1 cpi	GS	29
Select 20 cpi	ESC # 3	27 35 51
Character Sets		
Standard	ESC ! 0	27 33 48
Line Graphics	ESC ! 2	27 33 50
Double Height On	ESC US 1	27 31 49
Double Height Off	ESC US 0	27 31 48
Double Width Printing	US	31
Emphasized Printing On	ESC T	27 84
Emphasized Printing Off	ESC I	27 73
Enhanced Printing On	ESC H	27 72
Enhanced Printing Off	ESC I	27 73

Okidata Command	ASCII	Decimal
Form Feed	FF	12
Horizontal Tab, Execute	HT	9
Initialize Printer	ESC CAN	27 24
Italic On	ESC ! /	27 33 47
Italic Off	ESC ! *	27 33 42
Line Feed Commands		
w/ Carriage Return	LF	10
w/o Carriage Return	ESC DC2	27 18
n/144" (n = 0 to 127)	ESC % 5 n	27 37 53 n
Reverse	ESC LF	27 10
Line Spacing		
Set Spacing to 1/6"	ESC 6	27 54
Set Spacing to 1/8"	ESC 8	27 56
Set Spacing, in n/144" (n = 0 to 127)	ESC % 9 n	27 37 57 n
Skip Over Perforation, in 1/3" increments (n = 1 to 9)	ESC G nn	27 71 nn
Skip Over Perforation Default	ESC % S 0	27 37 83 48
Paper Out Sensor Off	ESC E 1	27 69 49
Paper Out Sensor On	ESC E 0	27 69 48

Okidata Command	ASCII	Decimal
Print Quality		
Select HSD	ESC # 0	27 35 48
Select NLQ Courier	ESC 1	27 49
Select NLQ Gothic	ESC 3	27 51
Select Utility	ESC 0	27 48
Print Speed, Set to Full	ESC >	27 62
Print Speed, Set to Half	ESC <	27 60
Print Suppress On	DC3	19
Print Suppress Off	DC1	17
Proportional Spacing		
On	ESC Y	27 89
Off	ESC Z	27 90
Reset: Clear Print Buffer	CAN	24
Software I-Prime	ESC } 0	27 125 48
Subscript Printing On	ESC L	27 76
Subscript Printing Off	ESC M	27 77
Superscript Printing On	ESC J	27 74
Superscript Printing Off	ESC K	27 75
Top of Form, Set at Current Position	ESC 5	27 53

Okidata Command	ASCII	Decimal
Underline Printing On	ESC C	27 67
Underline Printing Off	ESC D	27 68
Uni-Directional Print On	ESC -	27 45
Uni-Directional Print Off	ESC =	27 61
Vertical Tab, Execute	VT	11

FCC/IC/CE Statements

Federal Communications Commission (FCC) Radio Frequency Interference (RFI) Statement for 120V Models

WARNING: This equipment has been tested and found to comply with the limits for a Class B digital device, pursuant to Part 15 of the FCC Rules. These limits are designed to provide reasonable protection against harmful interference in a residential installation. This equipment generates, uses and can radiate radio frequency energy and, if not installed and used in accordance with the instructions, may cause harmful interference to radio communications. However, there is no guaranteed that interference will not occur in a particular installation. If this equipment does cause harmful interference to radio or television reception, which can be determined by turning the equipment off and on, the user is encouraged to try to correct the interference by one or more of the following measures:

- Reorient or relocate the receiving antenna.

- Increase the separation between the equipment and receiver
 - Plug unit into an outlet on a circuit different from that to which the receiver is connected.
 - Consult the dealer or an experienced radio/television technician for help.
- ✓ It is the responsibility of the user to obtain the required shielded cable in order to ensure compliance of this equipment with FCC regulations.

Changes or modifications not expressly approved by Okidata may void your authority to operate this device.

Industry Canada (IC) Radio Frequency Interference (RFI) Statement for 120V Models

This Okidata apparatus complies with the Class B limits for radio interference as specified in the Industry Canada Radio Interference Regulations.

FCC RFI Statement for 230/240V Models

WARNING: This equipment has been tested and found to comply with the limits for a Class A digital device, pursuant to Part 15 of the FCC Rules. These limits are designed to provide reasonable protection against harmful interference when the equipment is operated in a commercial environment. This equipment generates, uses and can radiate radio frequency energy and, if not installed and used in accordance with the instructions, may cause harmful interference to radio communications. Operation of the equipment in a residential area is likely to cause harmful interference, in which case the user will be required to correct the interference at their own expense.

- ✓ It is the responsibility of the user to obtain the required shielded cable in order to ensure compliance of this equipment with FCC regulations.

Changes or modifications not expressly approved by Okidata may void your authority to operate this device.

IC RFI Statement for 230/240V Models

This Okidata apparatus complies with the Class A limits for radio interference as specified in Industry Canada Radio Interference Regulations.

European Union Council of the European Communities Statement of Electromagnetic Conformance for 230/240V Models

This product complies with the requirements of the Council Directive 89/336/EEC on the approximation of the laws of the member states relating to electromagnetic compatibility.

European Union Council of the European Communities Statement of Safety Conformance for 230/240V Models

This product is in conformity with Directive 73/23/EEC on the harmonization of the laws of member states relating to electrical equipment designed for use within certain voltage limits.

Index

7 or 8 bit graphics,
menu item 28, 29

A

Accessories 47
ALARM light 19
Auto
 CR menu item 28, 29
 feet XT menu item 29
 gap
 LF menu item 28, 29
 select menu item 28, 29

B

Backspace
 command 49, 51, 53
Bar codes 23, 40
Baseline 12
Bottom margin menu item ... 29
Buffer
 clear (I-Prime) 30
 receive 40
Buttons, control panel 20

C

Cable, computer 5
Carbonless forms
 specifications 40
Card stock specifications 40
Carriage return
 command 49, 51, 53
Character pitch 23
 button 20
 commands 49, 51, 53
 lights 19
Character set
 commands 51, 53
 menu item 26, 29
Characters per line 39
Code page menu item 26, 29
Commands, printer 49-52
Continuous forms
 tear-off feature 32-33
 jams, clearing 15-16
 loading 7-9
 park feature 33
 specifications 40

Continuous forms (cont.)

 switching to single
 sheets 33
 tear feature 32
Control panel 19-24
Courier typeface 23, 39
Customer information
 center 43-44
Cut sheet
 feeders 47
 specifications 40

D

Defaults
 menu mode 26-29
 top of form 12
DEL code 30
Dimensions 41
Double width and height
 size menu item 31
 commands 49, 51,
Drivers, printer 14

E

Electrical requirements 41
Emphasized print
 commands 49, 51, 53
Emulation mode
 menu item 26, 29
Emulations 14, 39
Enhanced printing
 commands 49, 51, 53
Envelope specifications 40
Epson FX emulation 14
 commands 49-50

F

FF/LOAD button 20
Font sample test 13
Fonts 23, 39
Form
 feed commands 49, 51, 53
 length commands 50, 51, 53
 tear-off menu item . 26, 27, 30
 wait time 31

G

Gap control menu
 item 27, 30
Gothic typeface 23, 39
Graphics menu item 28, 30
 resolution 39
GROUP button 20

H

Horizontal tab
 command 50, 51, 53
Humidity requirements 41

I

IBM Proprinter emulation 14
 commands 51-52
Installation 1-14
Interfacing 5
Interleaf forms
 specifications 40
I-Prime menu item 29, 30
Italics
 print
 commands 49, 51, 53
 style 31
ITEM button 20

J

Jams, paper 15-16
Justification commands 50

L

Label specifications 40
Language set menu
 item 26, 30
Letter Gothic typeface 23, 39
LF button 20
Lights, control panel 19
Line
 feed commands 50, 52, 53
 spacing
 commands 50, 52, 53
 spacing menu
 item 26, 27, , 30
Loading paper 7-11

M

Maintenance 15-17
Manuals, ordering 46
Margin, bottom, menu
 item 29
Material Safety Data Sheet
 (MSDS) 63

Menu light 19
MENU button 20
Menu mode 24-31
 buttons 21
 entering 24
 exiting 24
 resetting to defaults 24
 sample printout 25
 settings 26-29
MICROLINE Standard
 emulation 14
 commands 53-54

O

Operator panel function
 menu item 28, 30
Overscore commands 52

P

Page length menu
 item 27, 30
Page width menu item 27, 30

Paper

 installation 7-11
 jams 15-16
 lever 7, 10
 loading 7-11
 out override menu
 item 28, 30
 out sensor
 commands 50, 52, 53
 quality
 commands 50, 52, 54
 rear feed 7-9
 reference marks 8
 single sheets 10-11
 specifications 40
 speed commands 50, 54
 suppress mode
 commands 50, 52, 54
Parallel interface 5
PARK button 20
Park paper feature 33
Parts, replacement 46
Pin 18 menu item 29, 30
Pitch menu item 26, 30
Postnet bar code 23, 40

Power		Problem solving 35-38	R	Semi auto gap (gap control) 30
connection 5		I-Prime signal 38	Rear feed paper jams 15-16	Serial interface 47
light 19		paper loading 37	Receive buffer size	SET button 20
Print		printhead gap 36	menu item 28, 31	Shield, ribbon 3
button 20		static electricity 38	Replacement parts 47	SHIFT button 20
DEL code menu		strange symbols 35	Reset	Shipping retainers 2-3
item 28, 30		top of form 37	button 20	SI select pitch menu
lights 19	Proportional		inhibit menu item 28, 31	items 28, 31
mode menu item 26, 30	character pitch 23		printer	Single sheet paper
quality 22	spacing		commands 50, 52, 54	jams 16
registration menu	commands 50, 52, 54		Resident fonts 39	loading 10-11
item 28, 31	menu item 26, 31	Proprinter emulation 14	Resolution, graphics 39	switching to continuous
speed 39	Proprinter emulation 14	commands 51-52	Ribbon cartridge	forms 33
start position 12	Protective film 1-2	Pull tractors and push	install/replace 3-4	Size menu item 26, 31
suppress effective	Pull tractors and push	tractors 47	life 4	Skip over perforation
menu item 28, 31	tractors 47		MSDS 63	commands 50, 54
Printer		Q	replacement 46	menu item 26, 27, 31
commands 49-54		QUIET	shield 3	Slashed zero 26, 31
drivers 14		button 20	Roll paper stand 47	Software I-Prime
Printhead		light 19	Rolling ASCII test 13	commands 50, 52, 54
gap control menu item 30			S	Stop printing command 52
gap adjust menu			SEL	Style menu item 26, 31
item 28, 31			button 20	Subscript
life 39			light 19	commands 50, 52, 54
replacement 46			Self tests 13	Superscript
specifications 39				commands 50, 52, 54

T

- TEAR button20
- Tear feature32
- Temperature requirements41
- Tests 13
- Time out print menu
 - item 28, 31
- Time, wait, menu item 27, 31
- Top of form 12
 - commands 52, 54
- Transparency
 - specifications40
- Troubleshooting (see also
 - Problem Solving) 35-38
 - paper jams 15-16
- Typefaces 23, 39

U

- Underline commands 51, 52, 54
- Unidirectional printing
 - commands51, 52, 54
- Unpacking 1

V

- Vertical tab
 - commands 51, 52, 54

W

- Wait time menu item27, 31
- Weight41

Z

- Zero character
 - menu item26, 31

Material Safety Data Sheet (MSDS)

Material Safety Data Sheet (MSDS)

58304701

For Black Ribbon (P/N 52107001)

For more information, contact Okidata at:

2000 Bishops Gate Blvd.
Mount Laurel, NJ 08054-4620

*For Emergency Information,
call 1-800-OKIDATA.*

Emergency First Aid Procedures

Emergency	Procedure
Contact occurs with eyes.	Flush eyes with large quantities of water for 15 minutes, keeping eyelids open with fingers. Seek medical attention.
Contact occurs with skin	Wash thoroughly with soap and water.

Current as of September 30, 2001

Hazardous Ingredients

Carbon Black

CAS# 1333-86-4

OSHA PEL 3.5 mg/m³

ACGIH TLV Not applicable

Coloring Material

CAS# Not applicable

OSHA TWA Not applicable

ACGIH TLV Not applicable

Oil

CAS# Not applicable

OSHA TWA Not applicable

ACGIH TLV Not applicable

Additives

CAS# Not applicable

OSHA TWA Not applicable

ACGIH TLV Not applicable

Nylon 6-6 Fabric

CAS# Not applicable

OSHA TWA Not applicable

ACGIH TLV Not applicable

Physical Data

Melting Point: Not applicable

Boiling Point: Not applicable

Vapor Pressure: Not applicable

Vapor Density (Air = 1): Not applicable

Evaporation Rate (Butyl Acetate = 1): Not applicable

Specific Gravity (H₂O=1): No data available

Solubility in Water: No data available

Appearance and Odor: Nylon 6-6 fabric impregnated with liquid black ink

Fire and Explosion Hazard Data

Flash Point (Method Used): Not applicable

Flammable Limits, LEL/UEL: Not applicable

Extinguishing Media: Water, CO₂, Dry Chemical or Foam

Special Fire and Explosion Procedures: Not applicable

Unusual Fire and Explosion Hazards: None

Health Hazard Data

Routes of Entry: Ingestion, Eyes, Skin

Health Hazards: None

Reactivity Data

Stability: Stable

Polymerization: Will not occur.

Hazardous Decomposition or Byproducts: None

Conditions to Avoid: Not applicable

Incompatibility (Materials to Avoid): None

Spill Cleanup and Disposal

Spill Cleanup: If the ribbon is inadvertently pulled out, it should be rewound on the reel using the take-up knob.

Waste Disposal: Follow appropriate federal, state and local regulations.

Safe Handling and Use

Respiratory Protection: Not applicable

Protective Gloves and/or Eye Protection: Not normally required. Protective gloves desirable in some cases.

Ventilation: Not applicable

Other Protective Equipment and/or Hygienic Practices: Not applicable

Special Precautions

Precautions for Handling or Storage: Store in a dark, cold place. Do not pull ribbon out of cartridge.

Other Precautions: Not applicable

To the best of the manufacturer's knowledge, the information contained herein is accurate. However, neither the manufacturer, nor any of its affiliates, make any representations or warranties (expressed or implied), nor assumes any liability (including liability for any direct, incidental, consequential, or other damages) with respect to the accuracy or completeness of the information contained herein. Such information may be (without limitation) invalid if the specified material is used in combination with another, in a particular process, or under unusual conditions. Determination of suitability of any material for any given purpose is the sole responsibility of the user who assumes all risk and responsibility therefor. All materials may present unknown hazards and should be used with appropriate caution. The manufacturer cannot and does not guarantee that the hazards described herein are the only ones that exist.